

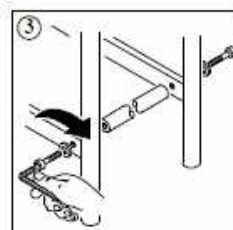

doctor POINT

Soluzioni medicali a portata di click

Cod. 27800 (+ accessori) **BARELLA FISSA**
Code 27800 (+ accessories) **PATIENT TROLLEY**

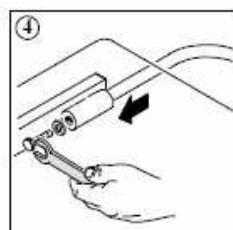
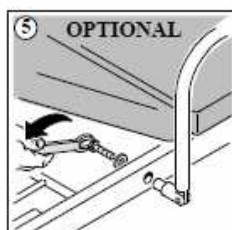
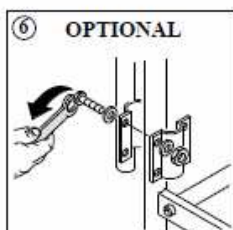
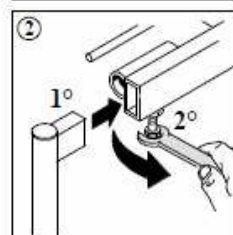
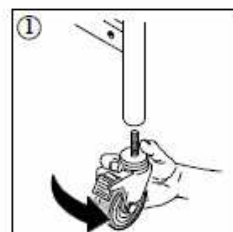
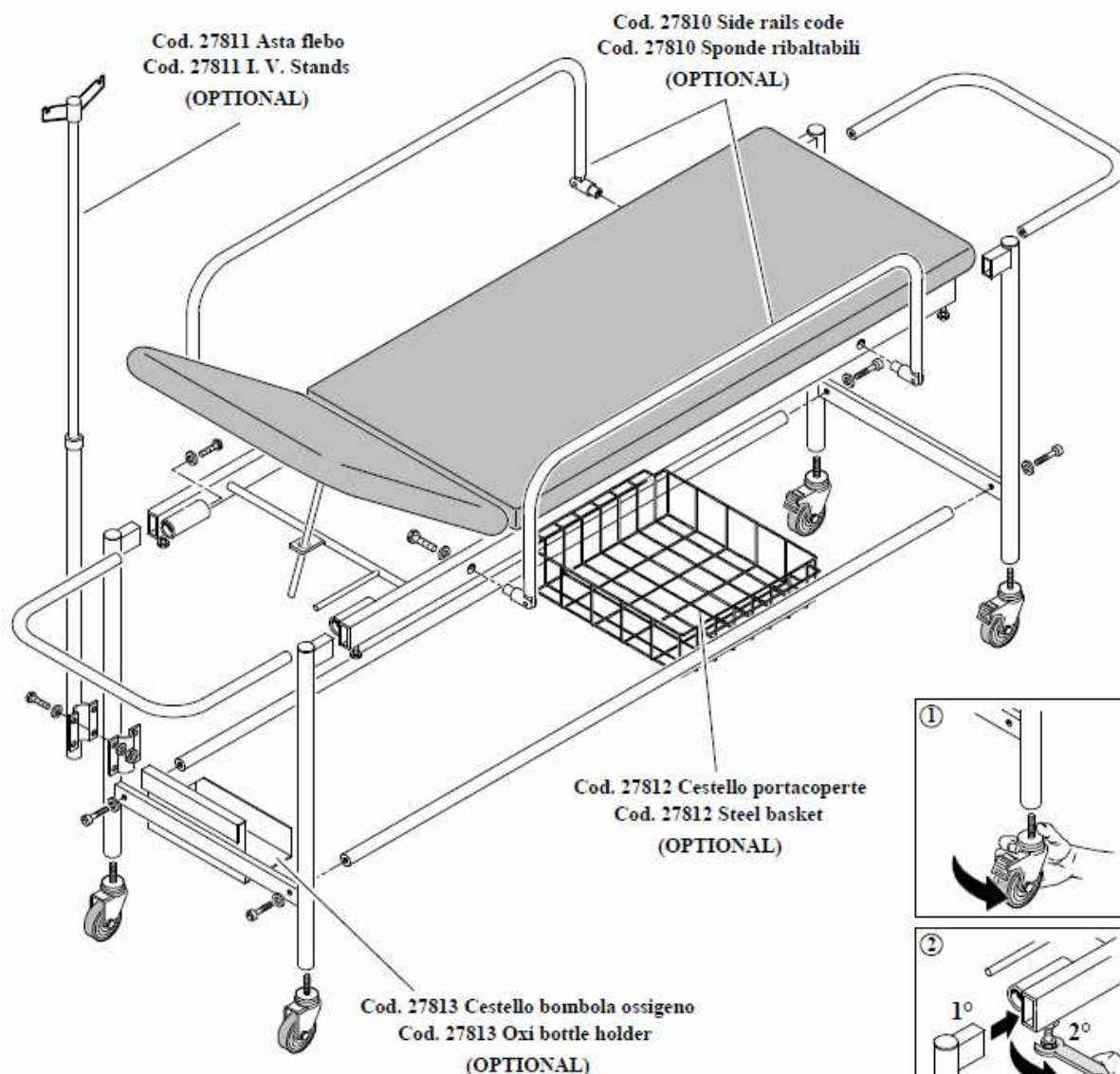

DOCTORPOINT s.r.l.

Sede Legale: via Ugo Foscolo n.15 - 28021 Borgomanero (No)

P.I. / C.F. / Reg.Imp.Novara 02191520036 REA 221049 Cap. Soc. 10.000,00 € Int. Versato

Sede Operativa: via Garibaldi, 9 (angolo piazza San Giuliano) - 28024 Gozzano (No)

Tel. +39 0322 1951117 Fax. +39 0322 060188 Web: www.doctorpoint.it Email: info@doctorpoint.it